

4SAFE OFF SW

Safety sensor for automatic swing doors

User's Guide for product version 0500 and higher
See product label for serial number

DESCRIPTION

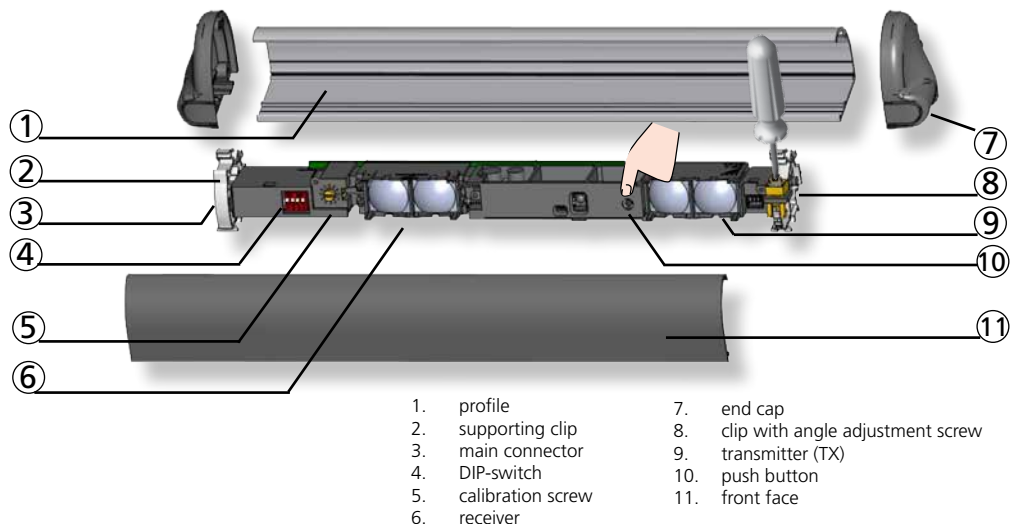

- | | |
|----------------------|-------------------------------------|
| 1. profile | 7. end cap |
| 2. supporting clip | 8. clip with angle adjustment screw |
| 3. main connector | 9. transmitter (TX) |
| 4. DIP-switch | 10. push button |
| 5. calibration screw | 11. front face |
| 6. receiver | |

TECHNICAL SPECIFICATIONS

Technology:	active infrared with background suppression
Emission field:	400 mm (W) x 70 mm (D) (at 2 m mounting height; 4 spots active)
Mounting height:	1.3 m to 3.5 m
Reaction time:	64 ms (typ)
Max. presence time:	infinite
Supply voltage:	12 V - 24 V AC +/-10% ; 12 V - 30 V DC -5%/+10% (to be operated from SELV compatible power supplies only)
Max current consumption:	95 mA @ 24 V AC / 70 mA @ 24 V DC; 170 mA @ 12 V AC / 130 mA @ 12 V DC (MASTER) 85 mA @ 24 V AC / 60 mA @ 24 V DC; 180 mA @ 12 V AC / 113 mA @ 12 V DC (other modules)
Output:	2 relays (free of potential contact)
Max. contact voltage	42 V AC/DC
Max. contact current	1 A (resistive)
Max. switching power	30 W (DC) / 42 VA (AC)
Max. number of modules:	4 (up to 6 if 24 V DC)
Reflectivity:	min. 5% at IR-wavelength of 850 nm
Degree of protection:	IP53
Temperature range:	-25 °C to +55 °C; 0-95% relative humidity, non condensing
Expected lifetime:	20 years
Norm conformity:	EN 61000-6-2; EN 61000-6-3; EN 50581

1 MOUNTING THE PROFILE



Mount the profiles as close as possible to the closing edge. Leave 2 cm for the black end caps. Take the position of the white clips into account before drilling and fastening the screws.

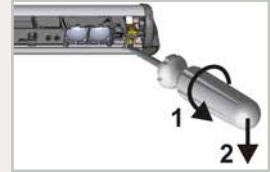

To loosen the modules, please use a screwdriver.

2 POSITIONING THE MODULES

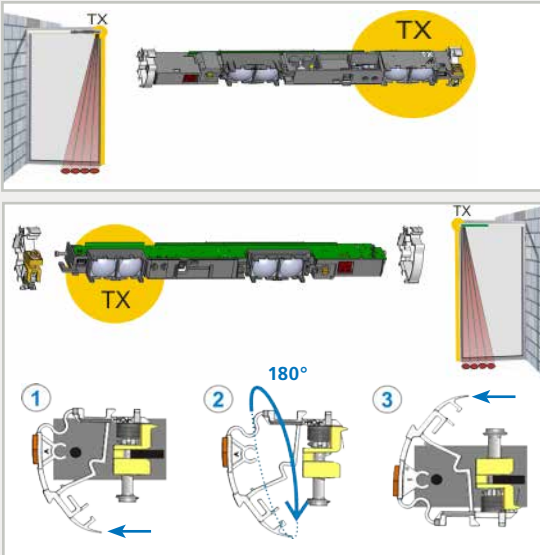

Place the transmitter (TX) next to the door edges that needs to be protected.

Position the angle adjustment clip next to the transmitter.

If necessary, turn the module and reposition the clips as indicated.

1. Detach the clips
2. Turn them by 180°
3. Reattach

3 WIRING

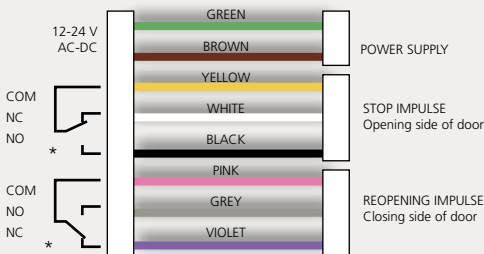

* Output status when sensor is operational

The module connected to the door controller becomes the **MASTER**.

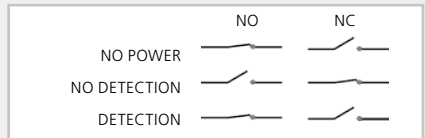



Plug the SLAVE CABLE between the modules in one of the two placements.



4 SETTINGS



 FACTORY VALUE

	MOUNTING SIDE	FREQUENCY	BACKGROUND	UNCOVERED ZONE
ON	RELAY 1 STOP 	FREQ A	ON	HIGH
OFF	RELAY 2 REOPENING 	FREQ B	OFF	LOW

LED during detection:
R1 > RED
R2 > GREEN

Set different frequencies on modules close to each other.

Not enough background reflectivity: switch to OFF

Approximate values at 2 m: high= 40 cm, low = 15 cm

5 CALIBRATION



A **SHORT** push on the button of the **MASTER** launches a calibration on **ALL MODULES**.

Do not stand in the detection field!



When the LED is off on all modules, the detection zone is OK.



The detection zone is too short: turn the screw clockwise.



The detection zone is too long: turn the screw anticlockwise.



Step out of the detection field.
If necessary, change angle or switch off background (DIP 3 = OFF).



Launch a new calibration.

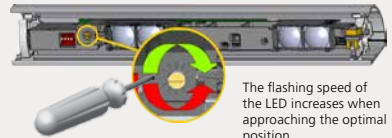



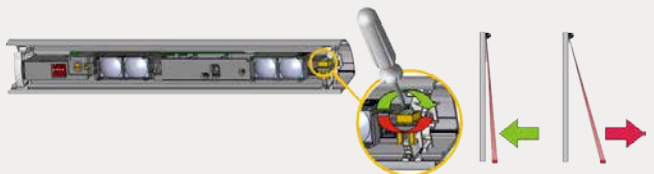

6 DOOR SAFETY CHECK

IMPORTANT: Test the good functioning of the installation before leaving the premises.

If necessary, position spots closer to or away from the door and **relaunch a calibration**.



LED-SIGNALS

 	<p>The RED or GREEN LED is ON sporadically or permanently.</p>	<p>Bad calibration</p>	<ol style="list-style-type: none"> 1 Launch a calibration.
		<p>Bad adjustment of the uncovered zone.</p>	<ol style="list-style-type: none"> 1 Check if the DIP-switch 4 is in correct position. 2 Launch a calibration.
		<p>The sensor is disturbed by lamps or another sensor.</p>	<ol style="list-style-type: none"> 1 Select a different frequency for each module (DIP 2). 2 Launch a calibration.
	<p>The ORANGE LED is on permanently.</p>	<p>The sensor encounters a memory problem.</p>	<ol style="list-style-type: none"> 1 Send the sensor back for a technical check-up.
	<p>The ORANGE LED flashes 4 x every 3 seconds.</p>	<p>The sensor receives not enough IR-energy.</p>	<ol style="list-style-type: none"> 1 Launch a new calibration and step out of the detection field. 2 Change angle of spots. 3 Switch off background (DIP 3: OFF).
	<p>The ORANGE LED flashes 5 x every 3 seconds.</p>	<p>Calibration error</p>	<ol style="list-style-type: none"> 1 Check mounting height. 2 Change position of calibration screw. 3 Launch a new calibration. 4 Switch off background (DIP3: OFF)

- The device cannot be used for purposes other than its intended use. All other uses cannot be guaranteed by the manufacturer of the sensor.
- The manufacturer of the door system is responsible for carrying out a risk assessment and installing the sensor and the door system in compliance with applicable national and international regulations and standards on door safety.
- The manufacturer of the sensor cannot be held responsible for incorrect installations or inappropriate adjustments of the sensor.
- Only trained and qualified personnel may install and setup the sensor.
- The warranty is invalid if unauthorized repairs are made or attempted by unauthorized personnel.



BEA hereby declares that the 4SAFE OFF SW is in conformity with the basic requirements and the other relevant provisions of the directives 2014/30/EU and 2011/65/EU.

The complete declaration of conformity is available on our website.



Only for EC countries: According to the European Guideline 2012/19/EU for Waste Electrical and Electronic Equipment (WEEE)

