

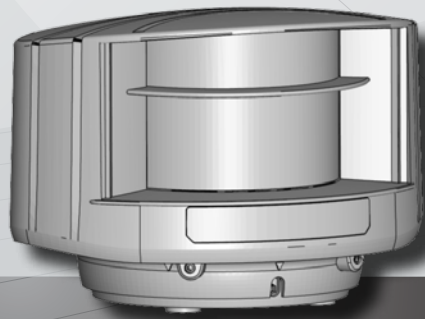

EN



## LZR<sup>®</sup>-RS310

3-DIMENSIONAL SAFETY SOLUTION  
FOR PLATFORM SCREEN DOORS



## DESCRIPTION

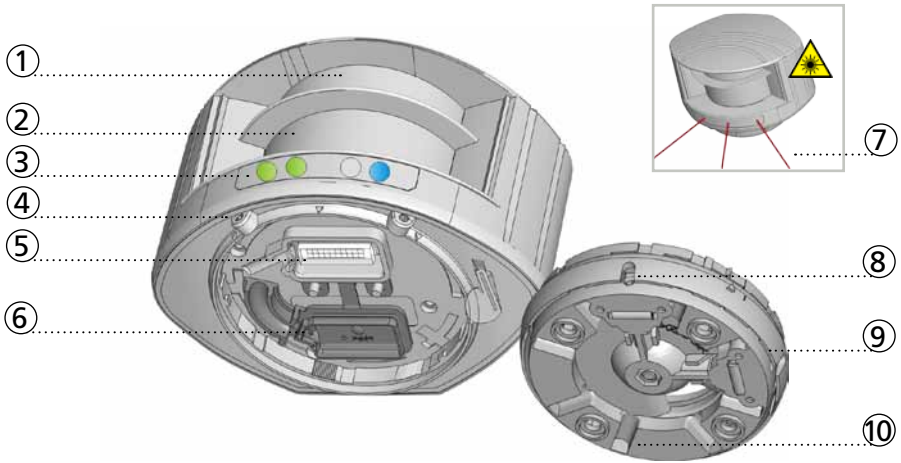

- |                                |  |
|--------------------------------|--|
| 1. laser sweep emission        | 6. protection cover                    |
| 2. laser sweep reception       | 7. visible laser beam (3)              |
| 3. LED-signal (4)              | 8. notch for tilt angle adjustment (2) |
| 4. screw for position lock (2) | 9. adjustable bracket                  |
| 5. connector                   | 10. cable conduit (4)                  |

## LED-SIGNAL

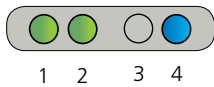

1. Detection LED: relay 1 - not used
2. Detection LED: relay 2 - safety field
3. Error LED
4. Power LED

### DETECTION LEDs

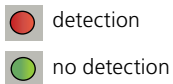

### ERROR LED

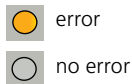

### POWER LED

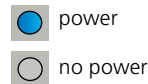

LED flashes quickly



LED flashes



LED flashes slowly



LED is off

**TIP!** All LEDs can be switched off and on again by remote control:



## SYMBOLS



Caution!  
Laser radiation



Remote control  
sequence



Possible  
remote control  
adjustments



Factory  
values

## SAFETY



The device contains IR and visible laser diodes.  
IR laser: wavelength 905nm; max. output pulse power 75W (Class 1 according to IEC 60825-1)  
Visible laser: wavelength 650nm; max. output CW power 3mW (Class 3R according to IEC 60825-1)

The visible laser beams are inactive during normal functioning.  
The installer can activate the visible lasers if needed.



### CAUTION!

Use of controls, adjustments or performance of procedures other than those specified herein may result in hazardous radiation exposure.

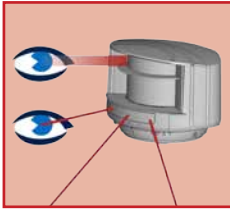

Do not look into the laser emitter or the visible red laser beams.



The warranty is void if unauthorized repairs are made or attempted by unauthorized personnel.



Only trained and qualified personnel may install and adjust the sensor.



Test the good functioning of the installation before leaving the premises.

The manufacturer of the door system is responsible for carrying out a risk assessment and installing the sensor and the door system in compliance with applicable national and international regulations and standards on door safety. Other use of the device is outside the permitted purpose and can not be guaranteed by the manufacturer. The manufacturer cannot be held responsible for incorrect installations or inappropriate adjustments of the sensor.

## INSTALLATION AND MAINTENANCE

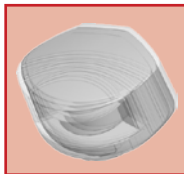

Avoid extreme vibrations.

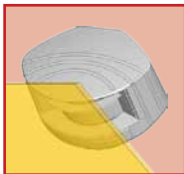

Do not cover the front screens.

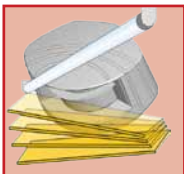

Avoid moving objects and light sources in the detection field.



Avoid the presence of smoke and fog in the detection field.

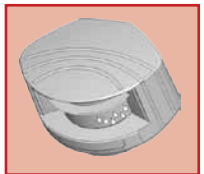

Avoid condensation.

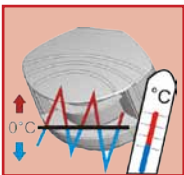

Avoid exposure to sudden and extreme temperature changes.



Avoid direct exposure to high pressure cleaning.



Do not use aggressive products to clean the front screens.

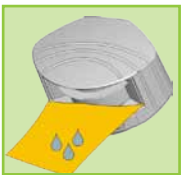

Wipe the front screens regularly with a clean and damp cloth.

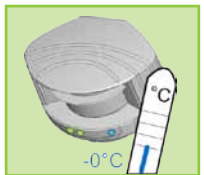

Keep the sensor permanently powered in environments where the temperature can descend below  $-10^{\circ}\text{C}$ .

# 1 MOUNTING

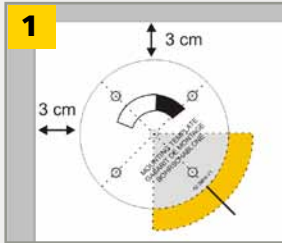

Use the adhesive mounting template to position the sensor correctly. The grey area indicates the detection range.

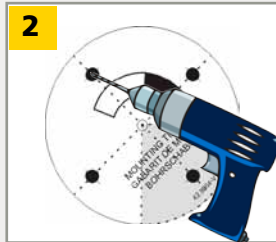

Drill 4 holes as indicated on the mounting template. Make a hole for the cable if possible.

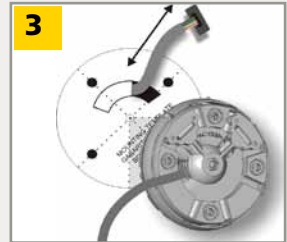

Pass the cable +/- 10 cm through the cable opening. If drilling an opening is not possible, use the cable conduits on the back side of the bracket.



Position the bracket and fasten the 4 screws firmly in order to avoid vibrations.



Open the protection cover, plug the connector and position the cable in the slit.



Close the protection cover and fasten it firmly.

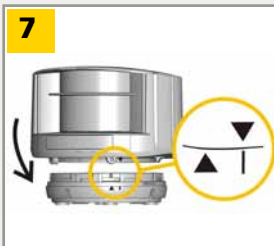

Position the housing on the bracket.



Turn the sensor until the two triangles are face to face.

## 2 WIRING

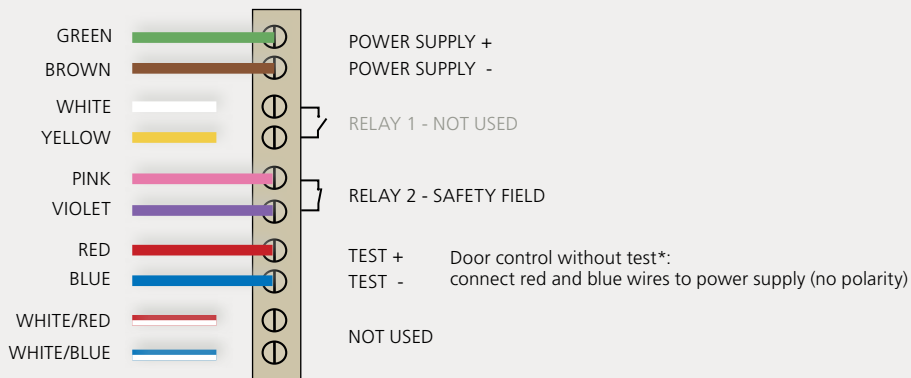

\*for more info, please contact SENSORIO

## 3 POSITIONING



Unlock the sensor and activate the visible laser beams.

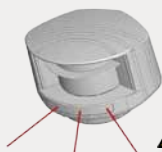

The visible laser beams indicate approximately the position of curtain C1 and limit the angle of the detection field.

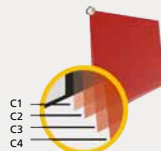

The visible laser beams stay activated for 15 minutes or can be turned off the same way they were activated.



Adjust the **lateral position** of the detection field.



Adjust the **tilt angle** of the detection field with the hex key.

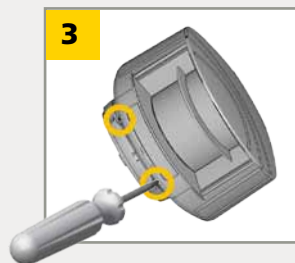

**Lock the position** of the mounting bracket to avoid malfunctioning in case of extreme vibrations.

### TIP!

In case you want to install 1 LZR on each side of the PSD in order to detect persons standing on the door threshold, the distance between the inner curtains of the 2 sensors should be max. 20 cm.

## 4 MOUNTING SIDE

Select the corresponding mounting side.

Stay outside of the detection field to avoid disturbances.

The sensor learns its environment and automatically determines the detection field(s). Both RED LEDs flash slowly and the 3 visible laser beams automatically light up during 30 seconds.



WITH BACKGROUND

The sensor memorizes the floor as reference point and signals a fault when its orientation is changed.

WITHOUT BACKGROUND

No reference point and therefore no signal when the sensor position is changed.



## 5 FIELD DIMENSIONS

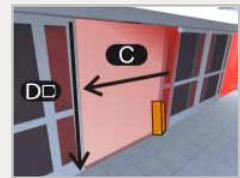
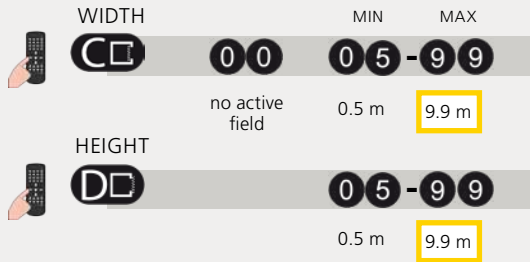

EXAMPLE  **C** **3** **5** for a field width of 3.5 m

**IMPORTANT:** Test the good functioning of the installation before leaving the premises.

## TEACH-IN

Launch a teach-in after changing the sensor position or when new objects are added to or changed in the detection zone.

The detection field should be free of snow buildups, heavy rain, snowfall, fog or other moving objects.



During teach-in, the sensor learns its surroundings and adapts the detection field shape to these. Objects in the detection field will be cut out.



## REMOTE CONTROL ADJUSTMENTS (OPTIONAL)

### DETECTION CURTAINS

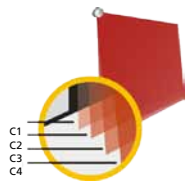

CURTAIN C1 C2 C3 C4

- 0 deactivate curtain
- 2 activate curtain

EX:

C1 + C2 are deactivated  
C3 + C4 are activated



All curtains are activated

The distances between the curtains depend on the mounting height and side. When mounted on the left, the distance between the first and the last curtain is approximately 10 cm for every meter (mounting height). **Example:** at 5 m the distance is 50 cm.

### IMMUNITY FILTER

FOR CRITICAL ENVIRONMENTS  
(RAIN, SNOW, FOG)

FOR CRITICAL OBJECTS

FOR CRITICAL ENVIRONMENTS (RAIN, SNOW, FOG)				FOR CRITICAL OBJECTS				
indoor	outdoor low	outdoor med	outdoor high	indoor	outdoor low	outdoor med	outdoor high	
	1	2	3	4	5	6	7	8

Choose between critical environments and critical objects.

### UNCOVERED ZONE



F2	0	1	2	3	4	
5	10	15	20	25	cm	

In case of snow, dead leaves, etc. increase the uncovered zone.

### MIN. OBJECT SIZE (approximate values)

	0	1	2	3	4	
off	5	10	15	20	cm	

### OUTPUT ACTIVATION DELAY approximate values

	0	1	2	3	4	5	6	7	8	9	
off	100	200	300	400	500	600	700	800	900	ms	

The outputs are triggered after a constant detection time of x ms (ex. value 3= 300 ms).

### OUTPUT CONFIGURATION

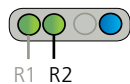

	1	2	3	4	
R1	A - NO	P - NC	P - NC	A - NO	A = active P = passive
R2	P - NC	A - NO	P - NC	A - NO	NO = normally open NC = normally closed



## HOW TO USE THE REMOTE CONTROL



After unlocking, the red LED flashes and the sensor can be adjusted by remote control.



If the red LED flashes quickly after unlocking, you need to enter an access code from 1 to 4 digits.



To end an adjustment session, always lock the sensor.

### ADJUSTING ONE OR MORE PARAMETERS

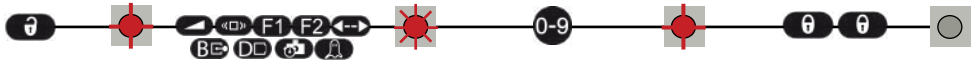

### CHECKING A VALUE

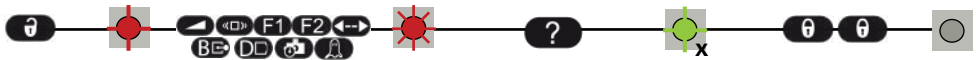

= field width: 4.2 m

= field width is defined by teach-in

### RESTORING TO FACTORY VALUES

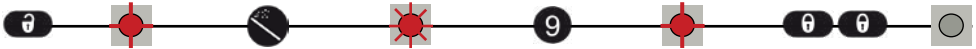

### SAVING AN ACCESS CODE

The access code is recommended for sensors installed close to each other.



### DELETING AN ACCESS CODE

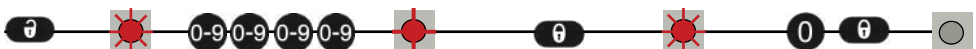

Enter the existing code

30 minutes after last use, the sensor locks the access to the remote control session. Cut and restore power supply. The remote control session is accessible again during 30 minutes.

X = NUMBER OF FLASHES = VALUE OF THE PARAMETER

## TROUBLESHOOTING

	No blue LED	There is no power.	<b>1</b> Check cable and connexion.
		The polarity of the power supply is inverted.	<b>1</b> Check the polarity of the power supply.
		All LEDs have been deactivated by remote control.	<b>1</b> Activate the LEDs by remote control.
	Only the blue LED is on.	The test input is not connected.	<b>1</b> Check wiring. The red and blue cable have to be connected to the test input or the power supply.
	The detection LED remains green.	The detection field is too small or deactivated.	<b>1</b> Check the size of the fields. <b>2</b> Launch a teach-in.
		The object size is too small.	<b>1</b> Decrease the min. object size.
	The detection LED remains red.	Someone or something is in the detection field.	<b>1</b> Step out of the field and/or remove the any object(s) from the field.
		The field is touching the floor, the wall or the door, which leads to detection.	<b>1</b> Activate the 3 red beams and check if the position of the sensor is correct. If not, adjust the hex screws. <b>2</b> Verify the field size. <b>3</b> Launch a teach-in.
		No background (reference point) is found.	<b>1</b> Check the position of the sensor. <b>2</b> Check the mounting side setting. If there is no background, set the mounting side to value 3 to 5. <b>3</b> Launch a new teach-in.
 	The orange LED is flashing and the detection LEDs are red.	The sensor is masked.	<b>1</b> Verify and clean the front screens with a damp cloth.
		The power supply voltage is exceeding the acceptable limits.	<b>1</b> Check the power supply voltage.
	The orange LED is on.	The sensor exceeds its temperature limits.	<b>1</b> Verify the outside temperature where the sensor is installed. Eventually protect the sensor from sunlight using a cover.
		Internal error	<b>1</b> Wait a few seconds. If the LED remains ON, reset the power supply. If the LED turns on again, replace the sensor.
		30 minutes after last use of the remote control, the sensor locks the access to the remote control session.	<b>1</b> Cut and restore power supply. The remote control session is accessible again during 30 minutes.
	The sensor does not respond to the remote control.	The batteries in the remote control are not installed properly or dead.	<b>1</b> Verify or replace the batteries.
		The remote control is badly pointed.	<b>1</b> Point the remote control towards the sensor, but with a slight angle. The RC should not be pointed in a right angle in front of the sensor.
		A reflective object is in close proximity to the sensor.	<b>1</b> Avoid highly reflective material in proximity to the sensor.
		You have to enter a code or the wrong code was entered.	<b>1</b> Cut and restore power supply. No code is required to unlock during the first minute after powering.
	The sensor does not unlock.		

## TECHNICAL SPECIFICATIONS

Technology:	laser scanner, time-of-flight measurement
Detection mode:	motion and presence
Max. detection range:	9.9 m x 9.9 m @ 2% remission factor*
Remission factor:	> 2 %
Angular resolution:	0,3516 °
Min. detected object size (typ.):	2,1 cm @ 3 m ; 3,5 cm @ 5 m ; 7 cm @ 10 m (in proportion to object distance)
Emission characteristics:	
IR laser:	wavelength 905 nm; max. output pulse power 75 W (CLASS 1)
Red visible laser:	wavelength 650 nm; max. output CW power 3 mW (CLASS 3R)
Supply voltage:	10-35 V DC @ sensor side
Power consumption:	< 5 W
Peak current at power-on:	1.8 A (max. 80 ms @ 35 V)
Cable length:	10 m
Response time:	typ. 20 ms; max. 80 ms
Output:	2 electronic relays (galvanic isolated - polarity free)
Max. switching voltage:	35 V DC / 24 V AC
Max. switching current:	80 mA (resistive)
Switching time:	t <sub>ON</sub> =5 ms; t <sub>OFF</sub> =5 ms
Output resistance:	typ 30 Ω
Voltage drop on output:	< 0.7 V @ 20 mA
Leakage current:	< 10 µA
Input:	2 optocouplers (galvanic isolated - polarity free)
Max. contact voltage:	30 V DC (over-voltage protected)
Voltage threshold:	Log. H: >8 V DC; Log. L: <3 V DC
Response time monitoring input:	< 5 ms
LED-signal:	1 blue LED: power-on status 1 orange LED: error status 2 bi-coloured LEDs: detection/output status (green: no detection; red: detection)
Dimensions:	125 mm (D) x 93 mm (W) x 70 mm (H) (mounting bracket + 14 mm)
Material:	PC/ASA
Colour:	black
Mounting angles on bracket:	-45 °, 0 °, 45 °
Rotation angles on bracket:	-5 ° to +5 ° (lockable)
Tilt angles on bracket:	-3 ° to +3 °
Protection degree:	IP65
Temperature range:	-30 °C to +60 °C if powered; -10 °C to +60 °C unpowered
Humidity:	0-95 % non-condensing
Vibrations:	< 2 G
Pollution on front screens:	max. 30 %; homogenous
Expected lifetime:	20 years
Norm conformity:	2006/95/EC: LVD; 2011/65/EU: RoHS 2; 2004/108/EC: EMC; EN 50155:2007; EN 60529:2001; IEC 60825-1:2007; EN 60950-1:2005; EN 61000-6-2:2005; EN 61000-6-3:2006 IEC 61496-1:2009; EN 61496-3:2008 ESPE Type 2; EN 62061:2005 SIL 2

Specifications are subject to changes without prior notice.  
All values measured in specific conditions.

\*For other options, please contact SENSORIO



A DIVISION OF BEA SA | LIEGE SCIENCE PARK | ALLÉE DES NOISETIERS 5 - 4031 ANGLEUR [BELGIUM]  
T +32 4 361 65 89 | F +32 4 361 28 58 | INFO@SENSORIO.BE | WWW.SENSORIO.BE



BEA hereby declares that the LZR®-RS310 is in conformity with the basic requirements and the other relevant provisions of the directives 2006/95/EC, 2011/65/EU and 2004/108/EC.

Angleur, April 2013

Jean-Pierre Valkenberg, Authorized representative

The complete declaration of conformity is available on our website: [www.sensorio.be](http://www.sensorio.be)



For EC countries: according to the directive 2002/96/EC for Waste Electrical and Electronic Equipment (WEEE)