

LZR[®]
SIGMA

People counting solution
Quickguide

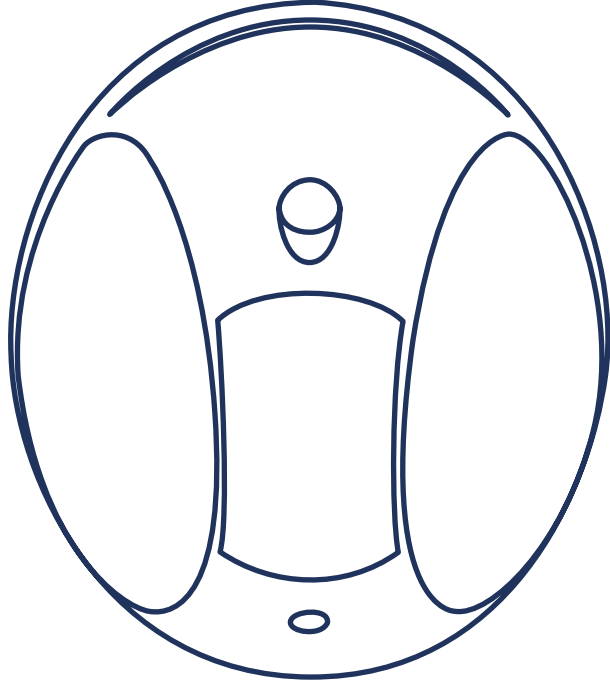

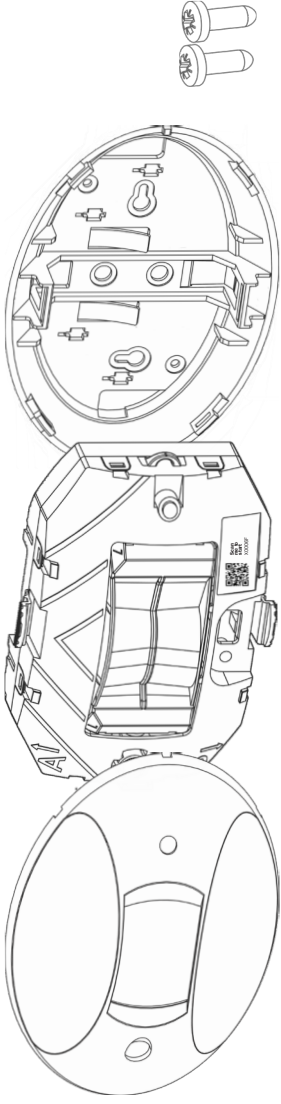

FRONT FACE

COUNTING HEAD

**SURFACE
MOUNTING BASE**

SCREWS



PoE

OR



POWER SUPPLY



LZR Sigma APP

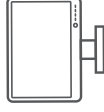

SENSORIO.COM

1 Where do you want to install SIGMA?

Sigma fits anywhere (doors, walls, ceilings). Just make sure you place it overhead.

In a pathway, an entrance, above a sliding door...

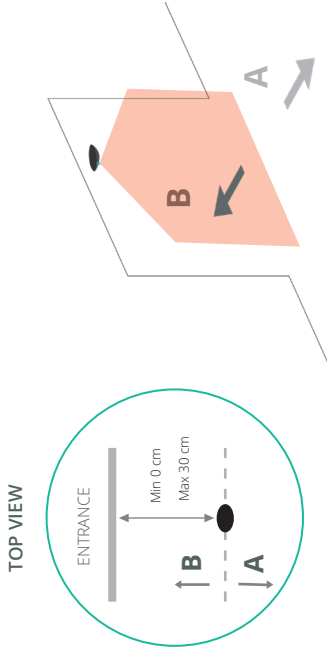

- Install SIGMA in the center of the pathway.
- Mount it **parallel** and at a maximum distance of **30 cm** from the entrance.

Above a swing door

Single leaf

When possible, install SIGMA on the closing side in the middle, outside the swing path (option 1).

When that is not possible, you can install SIGMA on the opening side. Make sure you place it right above the cutting edge (option2).

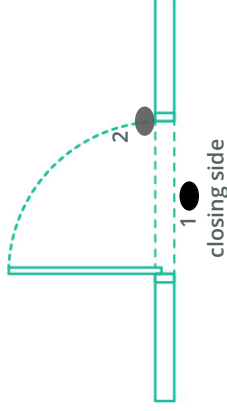

Double leaf

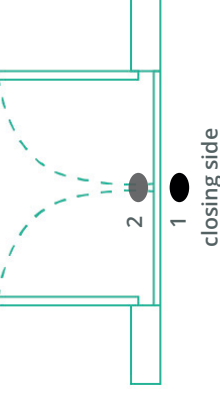

Install SIGMA in the center. Preferred side is the closing side, outside the swing path (option 1).

②

Define A and B directions

Choose a direction for your flow of people

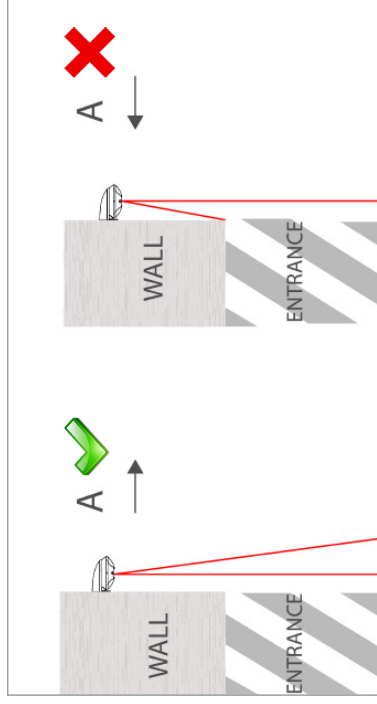
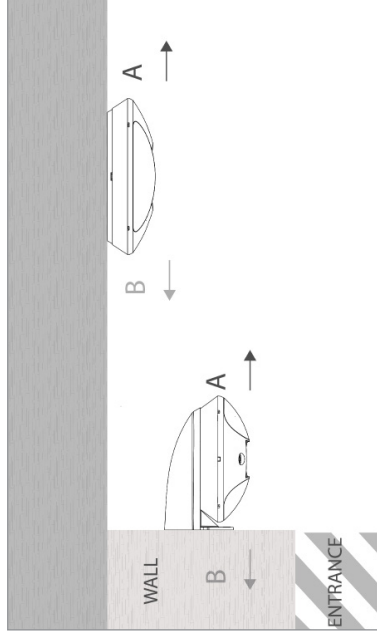
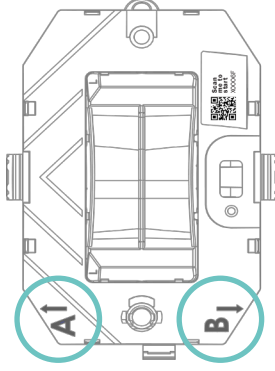

Make sure direction A is the one going away from the wall!

3) Pairing several sensors

Measure the width of the counting area to determine the number of sensors needed

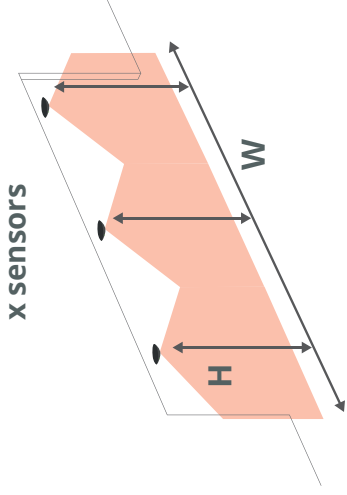
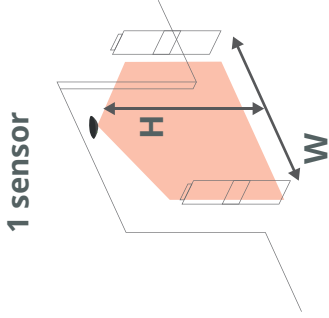

H	W max
2 m	1,6 m
2,5 m	2,5 m
3,5 m	3,5 m
4 m	4,5 m
5,5 m	7,5 m

If you use more than one sensor, check the detection fields using our online sizer tool: <https://www.meetsigma.io/sizer/>



Open Sigma

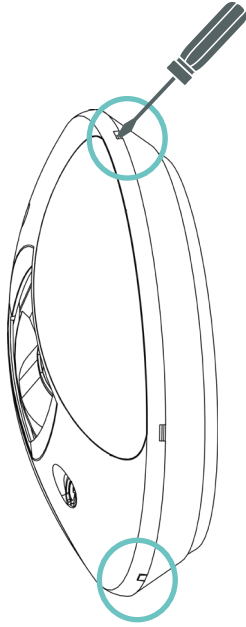

Remove the counting head by unclipping it

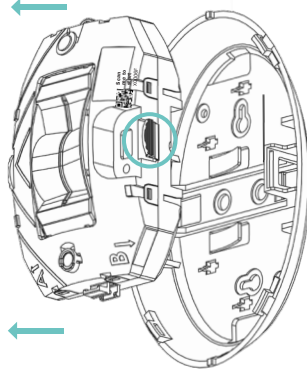

Caution - Do not open the counting head as it may result in hazardous radiation exposure.

Pass the cable through the base

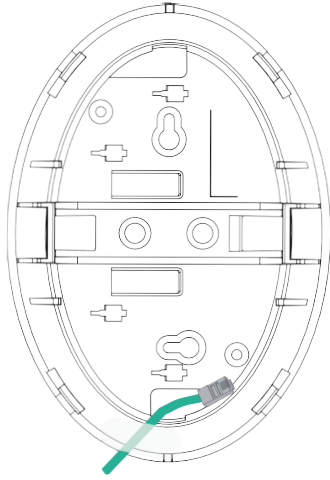

If necessary, a piece of the base can be removed with a cutting tool

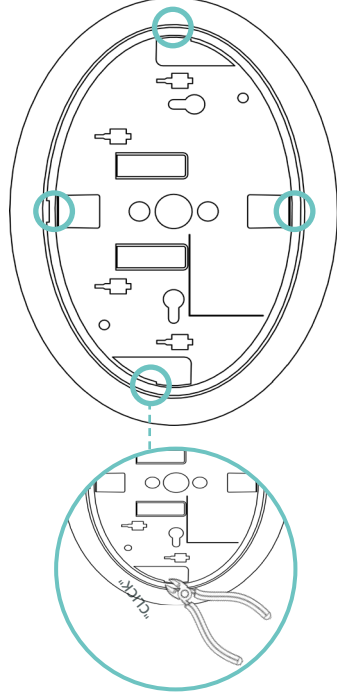

Fix the base on the ceiling

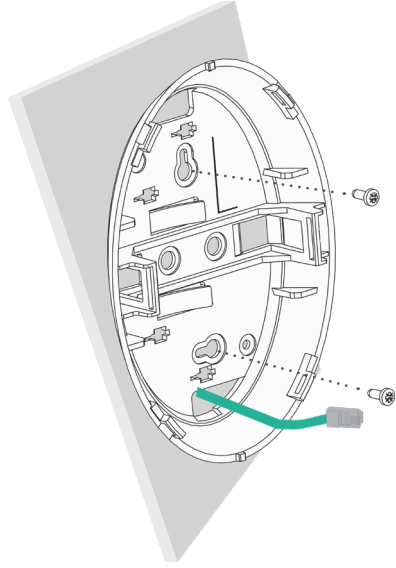

Or use BEA's wall mounting accessory to fix it on the wall

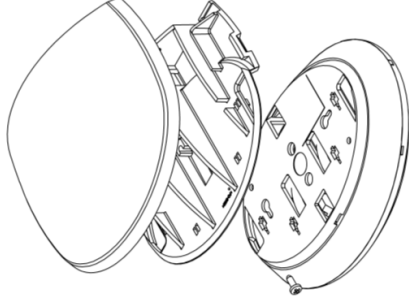

PZ2  8-10 mm

 3-4 mm

3 mm

Adapt screw length and type accordingly

Connect the cable to the counting head.
Clip the counting head to the base and close Sigma

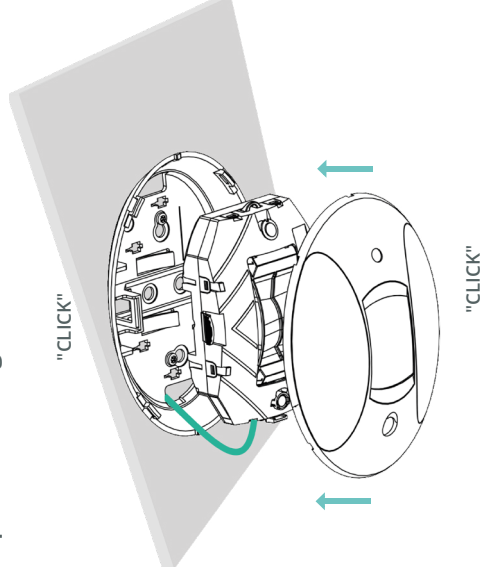

CLASS 1
LASER PRODUCT

5

Mobile App

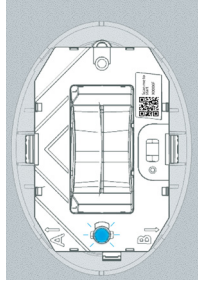

 Searching for network (0 - 5 min.)

 Connected to the network

Scan the QR Code (on the device or on the box) or download the LZR Sigma app on:

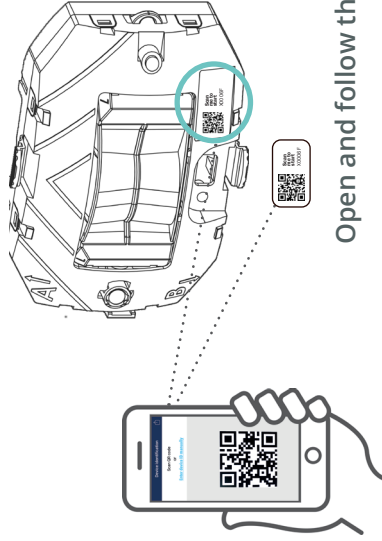

OR



Open and follow the app to complete the installation.



WEB SERVER

Static IP address : 192.168.1.2

User name: device ID (see tags on the device)

Password: *password*

ONLINE DEVICE MANAGER

Go to www.sensorio.com to manage your portfolio of sensors.

LZR SIGMA

asia.beasensors.com

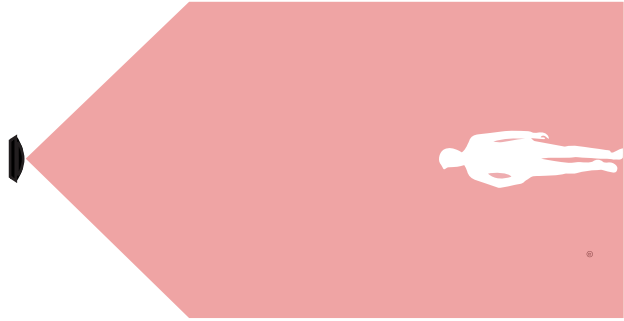

High precision



Independent of the environment



Easy Set Up Mobile App



Discover SIGMA
meetsigma.io







Autonomous connectivity



Device Manager
sensorio.com

> www.meetsigma.io



LED signal	Cause	Action
	No internet connection	The ethernet configuration is wrong or no cellular network is available Check the network connection Check if port 8883 is opened
	Device is not powered Note that the LED can also be off when the device is in normal operation	Check power supply
	Communicating with the app or with sensorio. Connected to the network	The device is communicating
	Searching for network	The device is connecting to the network
	Learning	Define the max. limit on your right or left
	Error	If this occurs, please contact BEA.
	Updating	Connection to the device is impossible Wait for update completion
	At least one of the following port is not opened : 123 (UDP) / 22 (TCP) / 443 (TCP)	Check network settings with your IT support

Legend:  Solid LED  Flashing LED

Technical Specifications

Technology	LASER scanner, time-of-flight measurement
Emission characteristics - IR LASER	Wavelength 905 nm ; average output power 0.05 mW; Class 1 (EN 60825)
Device dimensions	200 mm [L] x 142 mm [W] x 61 mm [H] (elliptical) (if mounted with recessed accessory : visible height 37 mm, invisible height 65 mm)
Temperature range	- 25° C to 55°C if powered (storage temperature -35° C to +70° C)
Humidity	0 - 95% non-condensing
Power	24 VDC ± 10% External DC power or PoE (IEEE802.3af) Power consumption Max. 12 W/Peak - Average 6 W
Data transfer	3G/2G cellular, Ethernet (cable cat. 5/6)
Supported frequencies / Power	GSM 850 - 824 to 849 MHz (Tx) - 869 to 894 MHz (Rx) - 2 W (Max. Power) E-GSM 900 - 880 to 915 MHz (Tx) - 925 to 960 MHz (Rx) - 2 W (Max. Power) DCS 1800 - 1710 to 1785 MHz (Tx) - 1805 to 1880 MHz (Rx) - 1 W (Max. Power) PCS 1900 - 1850 to 1910 MHz (Tx) - 1930 to 1990 MHz (Rx) - 1 W (Max. Power)
Installation height	2 m to 5.5 m
Counting width coverage	Ratio [0.8 - 1.35] depending on mounting height (cf. sizer tool: www.meetsigma.io/sizer/)
Ports	123 NTP (UDP) / 22 SFTP (TCP) / 443 HTTPS (TCP) / 8883 MQTTS (TCP)
Video validation	Resolution 160px x 120px, frame rate 15 fps (for counting proof purposes only)
Counting data refresh rate / granularity	1 min. (granularity 1 min.) to 24h (granularity 5 min.)
Protection degree	IP53
Conformity	BEA hereby declares that the radio equipment type LZR®-Sigma is in compliance with Directive 2014/53/EU (RED) and Directive 2011/65/EU (RoHS). The full text of the EU declaration of conformity is available on our website.



BEA SA | LIEGE SCIENCE PARK | ALLÉE DES NOISSETIERS 5 - 4031 ANGLEUR [BELGIUM] | T +32 4 361 65 65
| F +32 4 361 28 58 | INFO@BEA.BE | WWW.BEA-SENSORS.COM

THIS PRODUCT SHOULD BE DISPOSED OF SEPARATELY FROM UNSORTED MUNICIPAL WASTE

